

Technical Product Sheet

BV12-2466T-PN16 - Bare Shaft

Lug type butterfly valve, mounting between flanges PN16, bare shaft

Face to Face Standard: EN 558-1 Table 1 series 20



Item Number	Belven Ref.
121126T0200	BV12-2466T-PN16-DN200 - BARE SHAFT
121126T0250	BV12-2466T-PN16-DN250 - BARE SHAFT
121126T0300	BV12-2466T-PN16-DN300 - BARE SHAFT

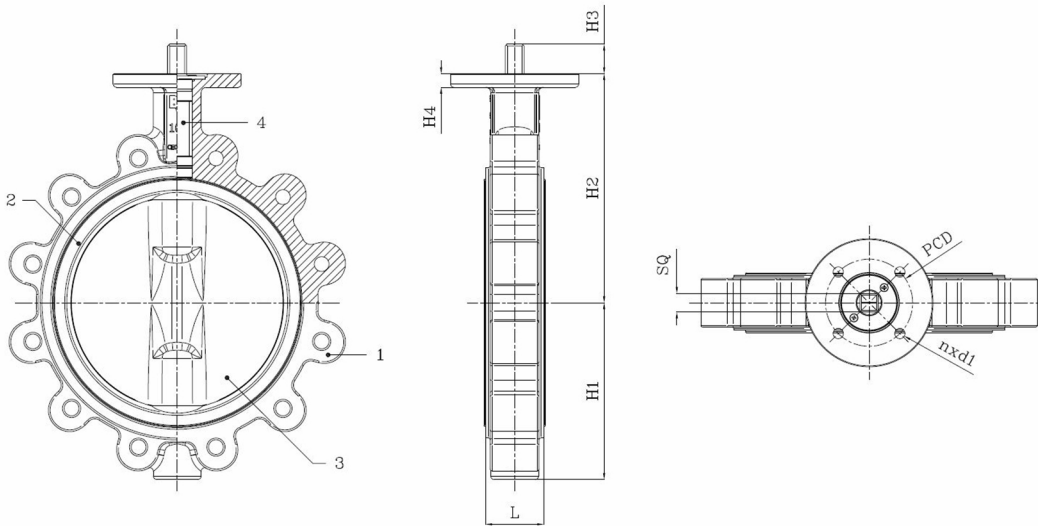

DN/Size	L	H1	H2	H3	H4	SQ	ISO	PCD	n x d1	Press.Cl.	Weight(kg)
DN200 (8")	60	168	237	34,5	16	17	F10	102	4 x d12	PN10	16.10
DN250 (10")	68	207	268,3	34,5	16	22	F10	102	4 x d12	PN10	29.70
DN300 (12")	78	243,5	308,5	34,5	16	27	F12	125	4 x d14	PN10	44.70

Item 1	Item 2	Item 3	Item 4
Body Material	Seat Material	Disc Material	Actuator Material
Ductile iron : GGG40 + Epoxy coating	PTFE	Stainless steel : CF8M	SS Stem AISI 416