

Technical Product Sheet

BV4-6666T-PN10/PN16/PN40 - Bare Shaft

Ball valve, full bore, split body, flanged PN10/PN16/PN40, bare shaft

Face to Face Standard: EN 558-1 series 27



Item Number	Belven Ref.
043D77F0015	BV4-6666T-PN40-DN015 - BARE SHAFT
043D77F0020	BV4-6666T-PN40-DN020 - BARE SHAFT
043D77F0025	BV4-6666T-PN40-DN025 - BARE SHAFT
043D77F0032	BV4-6666T-PN40-DN032 - BARE SHAFT
043D77F0040	BV4-6666T-PN40-DN040 - BARE SHAFT
043D77F0050	BV4-6666T-PN40-DN050 - BARE SHAFT

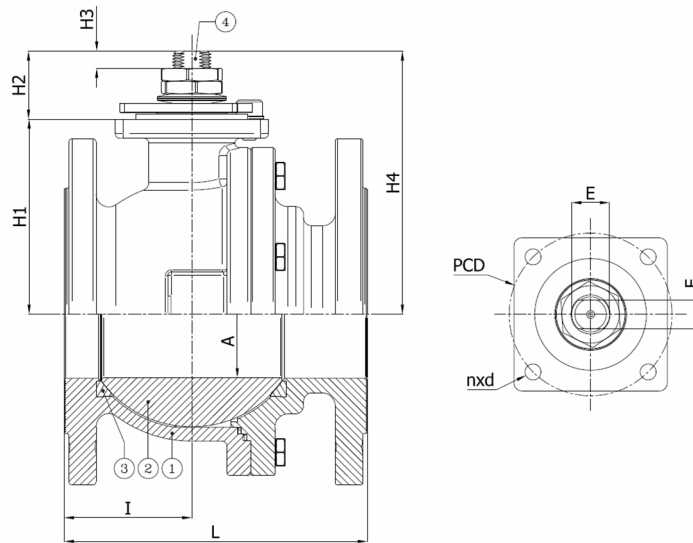

DN/Size	L	H1	H2	H3	H4	A	I	Press.Cl.	Weight(kg)
DN15 (1/2")	115	33	19	8	52	15	49	PN40	2.40
DN20 (3/4")	120	37	19	8	56	19	51	PN40	3.10
DN25 (1")	125	45	27,5	13	72,5	25	54	PN40	4.00
DN32 (1 1/4")	130	48,5	27,5	13	76	30	55	PN40	5.60
DN40 (1 1/2")	140	77	30	10	107	38	51,5	PN40	7.50
DN50 (2")	150	83,5	38,5	18	122	50,2	57,5	PN40	10.50

Item 1	Item 2	Item 3	Item 4
Body Material	Ball Material	Seat Material	Actuator Material
Stainless steel : 1.4408 (CF8M)	Stainless steel : A182-F316 / A351-CF8M	PTFE	SS Stem A182-F316

Belven N.V.

Blokhuisstraat 24 | 2800 Mechelen | Belgium

Tel. 015 29 40 70 | Fax. 015 20 14 13 | info@belven.com | www.belven.com

We keep the right to change the mentioned dimensions, weights, values and materials at any time without prior or direct notice.