

Technical Product Sheet

BV39-4545B-PN10/PN16



Wafer type swing check valve with spring, mounting between flanges PN10/16

Face to Face Standard: Factory standard



Item Number	Belven Ref.
393055B0032	BV39-4545B-PN16-DN032
393055B0040	BV39-4545B-PN16-DN040
393055B0050	BV39-4545B-PN16-DN050
393055B0065	BV39-4545B-PN16-DN065
393055B0080	BV39-4545B-PN16-DN080
393055B0100	BV39-4545B-PN16-DN100
393055B0125	BV39-4545B-PN16-DN125
393055B0150	BV39-4545B-PN16-DN150
393055B0200	BV39-4545B-PN16-DN200

DN150–DN300

DN32–DN40

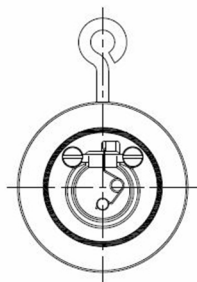

DN50–DN125

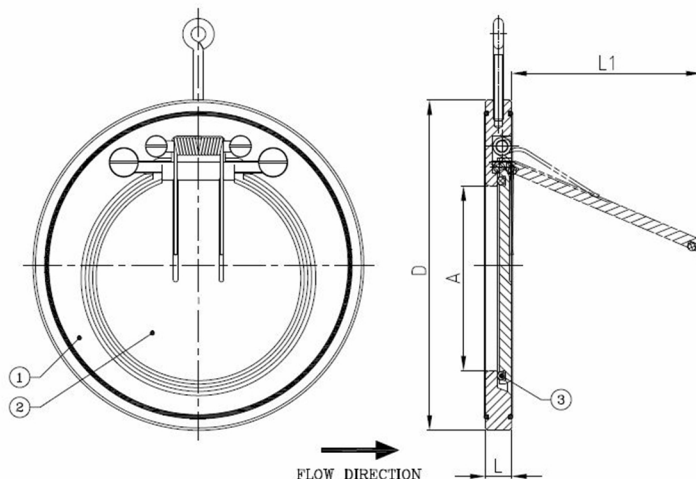
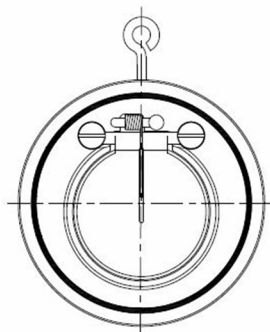

DN/Size	L	D	A	L1	Press.Cl.	Weight(kg)
DN32 (1 1/4")	15	85	18	22	PN16	0.60
DN40 (1 1/2")	16	95	22	25	PN16	0.80
DN50 (2")	14	109	32	37	PN16	0.90
DN65 (2 1/2")	14	129	40	50	PN16	1.20
DN80 (3")	14	144	54	61	PN16	1.50
DN100 (4")	18	164	70	77	PN16	2.40
DN125 (5")	18	195	92	98	PN16	3.30
DN150 (6")	20	220	112	120	PN16	4.60
DN200 (8")	22	275	154	160	PN16	7.70

Item 1	Item 2	Item 3
Body Material	Disc Material	Seat Material
Carbon steel : 1.0619 (WCB) zinc plated	Carbon steel : 1.0619 (WCB) zinc plated	NBR

Belven N.V.

Blokhuisstraat 24 | 2800 Mechelen | Belgium

Tel. 015 29 40 70 | Fax. 015 20 14 13 | info@belven.com | www.belven.com

We keep the right to change the mentioned dimensions, weights, values and materials at any time without prior or direct notice.