

Technical Product Sheet

BV12-2466T-PN16 - Gearbox

Lug type butterfly valve, mounting between flanges PN16, with gearbox

Face to Face Standard: EN 558-1 Table 1 series 20



Item Number	Belven Ref.
121126T3200	BV12-2466T-PN16-DN200 - GEARBOX
121126T3250	BV12-2466T-PN16-DN250 - GEARBOX
121126T3300	BV12-2466T-PN16-DN300 - GEARBOX

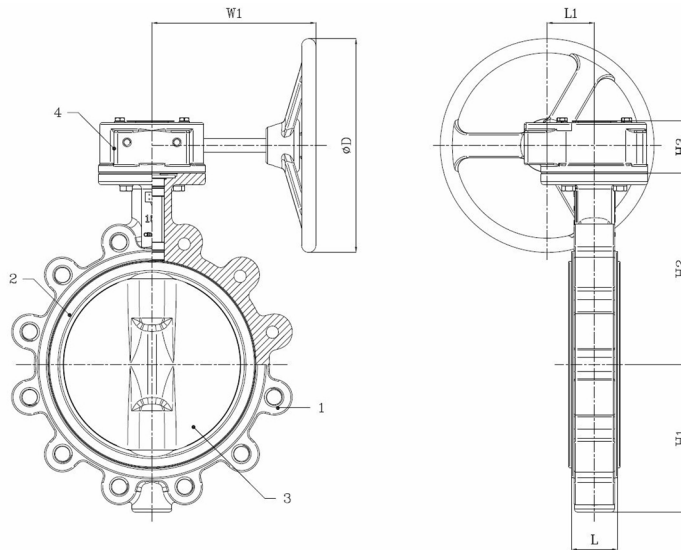

DN/Size	L	H1	H2	H3	L1	D	W1	Press.Cl.	Weight(kg)
DN200 (8")	60	168	237	80,5	63	300	237	PN10	27.00
DN250 (10")	68	207	268,3	80,5	63	300	237	PN10	36.00
DN300 (12")	78	243,5	308,5	80,5	78	300	225	PN10	67.00

Item 1	Item 2	Item 3	Item 4
Body Material	Seat Material	Disc Material	Actuator Material
Ductile iron : GGG40 + Epoxy coating	PTFE	Stainless steel : CF8M	Cast iron