

Technical Product Sheet



BV4-4766T-PN10/PN16/PN40 - Double Acting

Ball valve, full bore, split body, flanged PN10/PN16/PN40, with double acting actuator

Face to Face Standard: EN 558-1 series 27

The actuator is selected for 25°C water with a pressure drop of 16 bar with 6 bar supply air pressure and minimum 1 cycle per week



Item Number	Belven Ref.
043D07DA1015	BV4-4766T-PN40-DN015 - DA052
043D07DA1020	BV4-4766T-PN40-DN020 - DA052
043D07DA1025	BV4-4766T-PN40-DN025 - DA063
043D07DA1032	BV4-4766T-PN40-DN032 - DA063
043D07DA1040	BV4-4766T-PN40-DN040 - DA075
043D07DA1050	BV4-4766T-PN40-DN050 - DA075

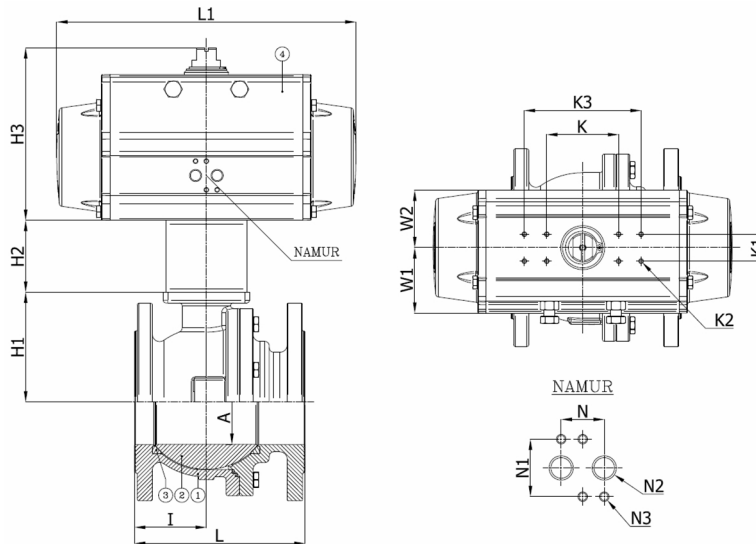

DN/Size	L	H1	H2	H3	A	I	L1	W1	W2	K	K1	N	N1	N2	N3	Press.Cl.	Weight(kg)
DN15 (1/2")	115	33	50	101,5	15	49	141	41	30	80	30	24	32	1/8"	M5	PN40	4.10
DN20 (3/4")	120	37	50	101,5	19	51	141	41	30	80	30	24	32	1/8"	M5	PN40	4.70
DN25 (1")	125	45	60	113	25	54	164	45	35,5	80	30	24	32	1/8"	M5	PN40	6.50
DN32 (1 1/4")	130	48,5	60	113	30	55	164	45	35,5	80	30	24	32	1/8"	M5	PN40	8.10
DN40 (1 1/2")	140	77	60	131	38	51,5	210	52,5	42	80	30	24	32	1/8"	M5	PN40	11.10
DN50 (2")	150	83,5	60	131	50,2	57,5	210	52,5	42	80	30	24	32	1/8"	M5	PN40	14.70

Item 1	Item 2	Item 3	Item 4
Body Material	Ball Material	Seat Material	Actuator Material
Low-temperature steel : 1.1156 (LCB)	Stainless steel : A182-F304 / A351-CF8	PTFE	Extruded aluminium

Belven N.V.

Blokhuisstraat 24 | 2800 Mechelen | Belgium

Tel. 015 29 40 70 | Fax. 015 20 14 13 | info@belven.com | www.belven.com

We keep the right to change the mentioned dimensions, weights, values and materials at any time without prior or direct notice.