

Technical Product Sheet

BV10-2366E-PN10/PN16/A150 - Aluminium Gearbox

Wafer type butterfly valve, mounting between flanges PN10/PN16/A150, with aluminium gearbox
 Face to Face Standard: EN 558-1 Table 1 series 20



Item Number	Belven Ref.
101026E5A050	BV10-2366E-PN16-DN050 - ALU GEARBOX
101026E5A065	BV10-2366E-PN16-DN065 - ALU GEARBOX
101026E5A080	BV10-2366E-PN16-DN080 - ALU GEARBOX
101026E5A100	BV10-2366E-PN16-DN100 - ALU GEARBOX
101026E5A125	BV10-2366E-PN16-DN125 - ALU GEARBOX
101026E5A150	BV10-2366E-PN16-DN150 - ALU GEARBOX
101026E5A200	BV10-2366E-PN16-DN200 - ALU GEARBOX
101026E5A250	BV10-2366E-PN16-DN250 - ALU GEARBOX
101026E5A300	BV10-2366E-PN16-DN300 - ALU GEARBOX

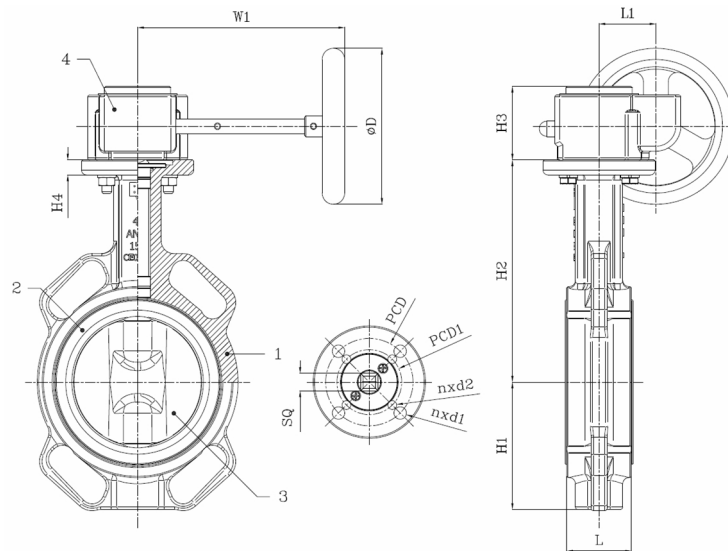

DN/Size	L	H1	H2	H3	L1	SQ	ISO	PCD	n x d1	PCD1	n x d2	D	W1	Press.Cl.	Weight(kg)
DN50 (2")	43	71,4	142,7	52,5	42	11	F05/F07	70	4 x d10	50	4 x d7	140	168,5	PN16	3.90
DN65 (2 1/2")	46	77,8	155,4	52,5	42	11	F05/F07	70	4 x d10	50	4 x d7	140	168,5	PN16	4.60
DN80 (3")	46	89	161,8	52,5	42	11	F05/F07	70	4 x d10	50	4 x d7	140	168,5	PN16	4.70
DN100 (4")	52	102	178	52,5	42	14	F07	70	4 x d10			140	168,5	PN16	6.00
DN125 (5")	56	123	190,5	52,5	42	14	F07	70	4 x d10			140	168,5	PN16	7.50
DN150 (6")	56	138	205,2	52,5	42	14	F07	70	4 x d10			140	168,5	PN16	7.60
DN200 (8")	60	168	237	60	60	17	F10	102	4 x d12			250	225,5	PN16	15.50
DN250 (10")	68	207	268,3	60	60	22	F10	102	4 x d12			250	225,5	PN16	22.60
DN300 (12")	78	243,5	308,5	87	81	27	F12	125	4 x d14			400	263	PN16	42.70

Item 1	Item 2	Item 3	Item 4
Body Material	Seat Material	Disc Material	Actuator Material
Cast iron : GG25 + Epoxy coating	EPDM	Stainless steel : CF8M	Aluminium

Belven N.V.

Blokhuisstraat 24 | 2800 Mechelen | Belgium

Tel. 015 29 40 70 | Fax. 015 20 14 13 | info@belven.com | www.belven.com

We keep the right to change the mentioned dimensions, weights, values and materials at any time without prior or direct notice.